

### [SPECIFICATION]

#### ■ CRANE

Description		Rough terrain crane with maximum lifting capacity 13 ton	
● Crane specification			
Maximum rated lifting capacity	5.3 m Boom	13,000kg × 1.7 m (Parts of line : 8)	
	9.04m Boom	6,000kg × 4.0 m (Parts of line : 4)	
	12.78 m Boom	6,000kg × 4.0 m (Parts of line : 4)	
	16.52m Boom	5,000kg × 4.5 m (Parts of line : 4)	
	20.26 m Boom	4,700kg × 4.0 m (Parts of line : 4)	
	24.0 m Boom	3,200kg × 5.5 m (Parts of line : 4)	
	3.6 m Jib	1,600kg × 75° (Parts of line : 1)	
5.5 m Jib	1,000kg × 70° (Parts of line : 1)		
Rooster	1,800kg (Parts of line : 1)		
Boom length	5.3m — 24.0m		
Fly jib length	3.6m — 5.5m		
Maximum rated lifting height	24.8m (Boom) 30.3m (jib)		
Hoisting line speed (winch up)	Main winch	118m / min. (at 5th layer)	
	Auxiliary winch	103m / min. (at 3rd layer)	
Hoisting hook speed (winch up)	Main winch	(Parts of line; 8) : 14.75m / min. (at 5th layer)	
	Auxiliary winch	(Parts of line; 1) : 103m / min. (at 3rd layer)	
High-speed lowering Rope speed	Main winch	180m / min (at 5th layer)	
	Auxiliary winch	155m / min (at 3rd layer)	
Boom derricking angle	-7.5° — 82°		
Boom derricking time	30s / -7.5° — 82°		
Boom extending speed	5.3 — 24.0m / 65s		
Slewing speed	2.4min <sup>-1</sup>		
Tail slewing radius	1,600mm		

#### ● Equipment and structure

Boom type	Box-shaped, 6-section hydraulically telescopic type (the 2nd and 3rd jib sections at the same time, the 4th, 5th and 6th jib sections at the same time)		
Jib type	2 sections (2nd section of draw-out type) Hydraulic stepless tilting type (offset angles 5° — 60° )		
Boom extension/retraction equipment	Two hydraulic cylinders and wire ropes used together		
Boom derricking/lowering equipment	One hydraulic cylinder of direct acting type with pressure-compensated flow control valve		
Winch system Main & Auxiliary winches	Two units of Single winch, Differential gear reduction type (built-in negative brake) with Automatic brake, High/Low speed switching system and Hydraulic compensated flow control valve.		
Slewing equipment	Equipped with Hydraulic motor drive and a planetary gear speed reducer (built-in negative brake)		
Slewing bearing	Ball bearing type		
Outriggers	Type	Hydraulic H-beam type (with float and vertical cylinder in single unit)	
	Extension width	4,750mm (Fully extended)	
		4,300mm (Intermediately extended)	
		3,700mm (Intermediately extended)	
		2,700mm (Intermediately extended)	
1,640mm (Fully retracted)			
Wire rope for hoisting	Main winch	Diameter: 11.2mm × Length: 132m	
	Auxiliary winch	Diameter: 11.2mm × Length: 65m	

#### ● Hydraulic equipment

Oil pump	Double variable plunger type, gear and plunger type		
Hydraulic motor	Hoisting motor	Axial plunger type	
	Slewing motor	Axial plunger type	
Control valve	Double acting with integral check and relief valves (With Hydraulic compensated flow control valve)		
Cylinder	Double acting type		
Oil reservoir capacity	150L		

#### ● Safety devices

	ACS (Automatic Crane System with voice alarm), Slewing automatic stop system, Working area restriction unit, Outrigger status detector, Natural lowering prevention unit for boom derricking/lowering, Natural lowering prevention unit for boom extension/retraction, Natural lowering prevention unit for jib derricking/lowering, Overhoist prevention device, Drum lock device, Automatic winch brake, Hydraulic safety valves, Outrigger lock pins, Slewing warning lamp, Hydraulic oil temperature warning device, Sling rope holding device
--	---

#### ● Standard equipment

	Air conditioner, Winch drum turning indication device, Working light (on boom, table and cab)
--	---

#### ● Operator's cab

	Tilt/telescopic steering wheel, Full-adjustable suspension seat (with Headrest and Armrest), Power window (with Window close reminder switch), Hot & cool box, Intermittent front & roof wipers (with Washer), Lunch table, AM/FM radio with Clock, Cigarette lighter, Step lamp, fire extinguisher, Floor mat
--	---

#### ● Optional equipment

	ACS external display, Loudspeaker, Door visor, Tangling prevention unit
--	---

#### ■ CARRIER

##### ● Carrier specification

Maximum traveling speed	49km/h
Grade ability	0.56 (tan θ)
Minimum turning radius (center of extreme outer tire)	6.5m (2 wheel steer)
	3.92m (4 wheel steer)

##### ● Engine

Model	Mitsubishi 4M50-TLE3A
Type	4 cycle, 4 cylinders, water cooled, direct injection turbo-charged diesel engine with intercooling
Piston displacement	4.899L
Max. power	129kW at 2,700min <sup>-1</sup>
Max. torque	530N·m at 1,600min <sup>-1</sup>

##### ● Equipment and structure

Drive system	Switches between 2 wheel drive (4×2) and 4 wheel drive (4×4)	
Torque converter	Engine mounted 3 elements 1 stage (with lock up clutch)	
Transmission	Remote mounted full automatic	
Number of speeds	4 forward & 1 reverse speed	
Axles	Front	Full floating type, with a two-stage reduction gear
	Rear	Full floating type, with a two-stage reduction gear
Suspension	Front	Taper - leaf spring (hydraulic locking device with shock absorber)
	Rear	Taper - leaf spring (hydraulic locking device with shock absorber)
Brake system	Service	Air-over hydraulic disk brake on 4 wheels (front and rear independent circuit)
	Parking	Spring applied, electrically air released parking brake mounted on front axle, internal expanding type
	Auxiliary	Exhaust pipe open/close valve type exhaust brake, Auxiliary braking unit for working
Steering	Model	All hydraulic power steering
	Mode	Front 2 wheel steering, rear 2 wheel steering, independent front and rear wheel steering (with automatic rear steering lock system)
Tire size	Front	275 / 80 R22.5 151 / 148J
	Rear	275 / 80 R22.5 151 / 148J
Fuel tank capacity	250 L	
Batteries	(12V-100AH) × 2	

##### ● Safety devices

	Emergency steering device, Rear wheel steering lock system (automatic), Brake fluid leak warning device, Auxiliary braking unit for working, Suspension lock, Engine overspeed alarm, Radiator coolant level warning device,
--	--

##### ● Standard equipment

	Aluminum outrigger plate, Electrically stowed side mirrors
--	--

##### ● Optional equipment

	Rearview camera, Left side view camera, Wheel chock
--	---

#### ■ GENERAL Dimensions

Overall length	7,440mm	
Overall width	1,995mm	
Overall height	2,845mm	
Wheel base	2,750mm	
Treads	Front	1,680mm
	Rear	1,680mm
Passenger capacity	One person	
Gross vehicle mass	Gross weight	approx. 13,765kg
	Front weight	approx. 6,790kg
	Rear weight	approx. 6,975kg

##### ● Stow the hooks in place before traveling.





● Before you use this machine, read the precautions in the instruction manual thoroughly to operate it correctly.

● KATO products and specifications are subject to improvements and changes without notice.

# RATED LIFTING CAPACITY

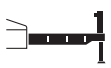
Based on ISO 4305  
Not exceed 75% of static tipping loads

## 5.3m — 24.0m Boom

Working radius (m)	 (4.75m)						 (4.3m)						 (3.7m)						 (2.7m)						
	Outriggers fully extended (360° full range)						Outriggers intermediately extended (over side)						Outriggers intermediately extended (over side)						Outriggers intermediately extended (over side)						
	5.3m Boom	9.04m Boom	12.78m Boom	16.52m Boom	20.26m Boom	24.0m Boom	5.3m Boom	9.04m Boom	12.78m Boom	16.52m Boom	20.26m Boom	24.0m Boom	5.3m Boom	9.04m Boom	12.78m Boom	16.52m Boom	20.26m Boom	24.0m Boom	5.3m Boom	9.04m Boom	12.78m Boom	16.52m Boom	20.26m Boom	24.0m Boom	
1.5	13.00	6.00	6.00				13.00	6.00	6.00				12.00	6.00	6.00				12.00	6.00	6.00				
1.7	13.00	6.00	6.00				13.00	6.00	6.00				12.00	6.00	6.00				12.00	6.00	6.00				
2.0	12.00	6.00	6.00	5.00			12.00	6.00	6.00	5.00			12.00	6.00	6.00	5.00			12.00	6.00	6.00	5.00			
2.5	10.00	6.00	6.00	5.00			10.00	6.00	6.00	5.00			10.00	6.00	6.00	5.00			8.50	6.00	6.00	5.00			
3.0	8.20	6.00	6.00	5.00	4.70		8.20	6.00	6.00	5.00	4.70		8.20	6.00	6.00	5.00	4.70		6.00	6.00	6.00	5.00	4.70		
3.5	7.00	6.00	6.00	5.00	4.70	3.20	7.00	6.00	6.00	5.00	4.70	3.20	7.00	6.00	6.00	5.00	4.70	3.20	4.70	4.70	4.60	4.50	4.40	3.20	
4.0	6.10	6.00	6.00	5.00	4.70	3.20	6.10	6.00	6.00	5.00	4.70	3.20	6.10	6.00	6.00	5.00	4.70	3.20	3.70	3.70	3.70	3.70	3.70	3.20	
4.5		5.50	5.40	5.00	4.50	3.20		5.50	5.40	5.00	4.50	3.20		5.10	5.10	5.00	4.50	3.20		3.00	3.00	3.10	3.10	3.00	
5.0		5.00	4.90	4.60	4.05	3.20		5.00	4.90	4.60	4.05	3.20		4.40	4.40	4.50	4.05	3.20		2.40	2.40	2.60	2.70	2.70	
5.5		4.50	4.40	4.20	3.70	3.20		4.50	4.40	4.20	3.70	3.20		3.80	3.70	3.90	3.70	3.20		2.00	2.00	2.20	2.30	2.30	
6.0		4.10	4.00	3.80	3.40	3.00		4.10	4.00	3.80	3.40	3.00		3.20	3.20	3.40	3.40	3.00		1.70	1.70	1.85	2.00	2.05	
6.5		3.70	3.65	3.50	3.15	2.80		3.65	3.60	3.50	3.15	2.80		2.80	2.75	2.95	3.05	2.75		1.40	1.40	1.60	1.70	1.75	
7.0		3.35	3.30	3.20	2.90	2.60		3.20	3.15	3.20	2.90	2.60		2.40	2.35	2.55	2.70	2.50		1.20	1.20	1.40	1.50	1.55	
8.0		2.70 (7.7m)	2.90	2.70	2.50	2.25		2.65 (7.7m)	2.45	2.60	2.50	2.25		1.95 (7.7m)	1.80	2.00	2.10	2.15		0.90 (7.7m)	0.85	1.05	1.15	1.20	
9.0			2.25	2.30	2.20	1.95			1.90	2.10	2.20	1.95			1.40	1.60	1.70	1.75			0.60	0.80	0.90	0.95	
10.0			1.80	2.05	1.95	1.75			1.50	1.70	1.85	1.75			1.05	1.25	1.35	1.45			0.35	0.55	0.65	0.75	
11.0			1.45	1.70	1.75	1.55			1.20	1.40	1.55	1.55			0.80	1.00	1.10	1.20			0.40	0.50	0.60		
12.0			1.35 (11.4m)	1.40	1.50	1.40			1.10 (11.4m)	1.15	1.30	1.35			0.70 (11.4m)	0.80	0.90	1.00			0.25	0.35	0.45		
13.0				1.15	1.30	1.25				0.95	1.10	1.15				0.65	0.75	0.85				0.20	0.30		
14.0				0.95	1.10	1.15				0.80	0.90	1.00				0.50	0.60	0.70					0.20		
15.0				0.80	0.90	1.00				0.65	0.75	0.85				0.40	0.50	0.55							
16.0					0.79	0.85					0.65	0.70					0.40	0.45							
17.0					0.68	0.74					0.55	0.60					0.30	0.35							
18.0					0.58	0.64					0.45	0.50						0.30							
19.0					0.51 (18.8m)	0.55					0.35 (18.8m)	0.40													
20.0						0.47						0.35													
21.0						0.41						0.30													
22.0						0.35						0.25													
22.5						0.32																			
Critical boom angle	—	—	—	—	—	—	—	—	—	—	—	—	—	—	—	—	—	23°	36°	—	—	19°	32°	44°	50°
Standard hook	for 13 ton						for 13 ton						for 13 ton						for 13 ton						
Hook mass	90kg						90kg						90kg						90kg						
Parts of line	8	4	4	4	4	4	8	4	4	4	4	4	8	4	4	4	4	4	8	4	4	4	4	4	



(Unit : Metric ton)

## 5.3m — 24.0m Boom

■ When the outriggers are not used



Working radius (m)	 (1.64m)					
	Outriggers completely retracted (over side)					
	5.3m Boom	9.04m Boom	12.78m Boom	16.52m Boom	20.26m Boom	24.0m Boom
1.5	8.00	6.00	6.00			
1.7	7.00	6.00	6.00			
2.0	5.60	5.40	5.00			
2.5	3.80	3.80	3.60	4.70		
3.0	2.80	2.80	2.70	2.70	2.60	
3.5	2.10	2.10	2.00	2.10	2.10	2.10
4.0	1.60	1.60	1.55	1.70	1.70	1.75
4.5		1.25	1.20	1.40	1.40	1.45
5.0		0.95	0.95	1.10	1.20	1.25
5.5		0.75	0.75	0.90	1.00	1.05
6.0		0.60	0.55	0.75	0.80	0.90
6.5		0.40	0.35	0.60	0.65	0.75
7.0		0.25		0.45	0.55	0.60
Critical boom angle	—	20°	54°	61°	66°	70°
Standard hook	for 13 ton					
Hook mass	90kg					
Parts of line	8	4	4	4	4	4

(Unit : Metric ton)

Working radius (m)													Working radius (m)
	Stationary on rubber						Pick & carry (less than 2 km/h)						
	5.3m Boom	9.04m Boom	12.78m Boom	5.3m Boom	9.04m Boom	12.78m Boom							
	Over front	360° full range	Over front	360° full range	Over front	360° full range	Over front	360° full range	Over front	360° full range	Over front	360° full range	
1.5	3.60	2.80	3.60	2.80	3.60	2.80	3.20	2.00	3.20	2.00	3.20	2.00	1.5
2.0	3.40	2.80	3.40	2.80	3.40	2.80	3.00	2.00	3.00	2.00	3.00	2.00	2.0
2.5	3.10	2.15	3.10	2.10	3.10	2.05	2.80	1.55	2.75	1.50	2.65	1.45	2.5
3.0	2.65	1.60	2.60	1.55	2.55	1.50	2.40	1.10	2.30	1.05	2.20	1.00	3.0
3.5	2.30	1.25	2.20	1.20	2.10	1.10	2.00	0.85	1.90	0.75	1.80	0.65	3.5
4.0	2.00	0.90	1.90	0.80	1.70	0.70	1.70	0.60	1.65	0.50	1.50	0.40	4.0
4.5			1.60	0.50	1.40	0.40			1.40	0.30	1.25		4.5
5.0			1.30		1.10				1.15		1.00		5.0
5.5			1.10		0.95				0.95		0.85		5.5
6.0			0.90		0.80				0.80		0.70		6.0
7.0			0.50		0.50				0.45		0.45		7.0
Critical boom angle	—	—	26°	54°	52°	66°	—	—	26°	54°	52°	68°	Critical boom angle
Standard hook	for 13 ton						for 13 ton						Standard hook
Hook mass	90kg						90kg						Hook mass
Parts of line	4						4						Parts of line

(Unit : Metric ton)

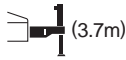

## 24.0m Boom + 3.6m Jib

 (4.75m)								 (4.3m)								 (3.7m)																
Outriggers fully extended (360° full range)								Outriggers intermediately extended (over side)								Outriggers intermediately extended (over side)																
Boom angle (°)	Offset 5°		Offset 25°		Offset 45°		Offset 60°		Boom angle (°)	Offset 5°		Offset 25°		Offset 45°		Offset 60°		Boom angle (°)	Offset 5°		Offset 25°		Offset 45°		Offset 60°							
	Working radius (m)	Load (ton)	Working radius (m)	Load (ton)	Working radius (m)	Load (ton)	Working radius (m)	Load (ton)		Working radius (m)	Load (ton)	Working radius (m)	Load (ton)	Working radius (m)	Load (ton)	Working radius (m)	Load (ton)		Working radius (m)	Load (ton)	Working radius (m)	Load (ton)	Working radius (m)	Load (ton)	Working radius (m)	Load (ton)						
82	4.4	1.60	5.8	1.50	6.5	1.00	6.8	0.65	82	4.4	1.60	5.8	1.50	6.5	1.00	6.8	0.65	82	4.4	1.60	5.8	1.50	6.5	1.00	6.8	0.65						
80	5.2	1.60	6.4	1.50	7.2	1.00	7.4	0.65	80	5.2	1.60	6.4	1.50	7.2	1.00	7.4	0.65	80	5.2	1.60	6.4	1.50	7.2	1.00	7.4	0.65						
75	7.8	1.60	8.7	1.17	9.5	0.93	9.6	0.65	75	7.8	1.60	8.7	1.17	9.5	0.93	9.6	0.65	75	7.8	1.60	8.7	1.17	9.5	0.93	9.6	0.65						
70	10.1	1.25	11.1	0.98	11.6	0.85	11.8	0.65	70	10.1	1.25	11.1	0.98	11.6	0.85	11.8	0.65	70	10.1	1.25	11.1	0.98	11.6	0.85	11.8	0.65						
65	12.3	1.05	13.1	0.88	13.6	0.77	13.8	0.65	65	12.3	1.05	13.1	0.88	13.6	0.77	13.8	0.65	65	12.2	0.90	13.1	0.77	13.6	0.77	13.8	0.65						
60	14.3	0.90	15.1	0.76	15.6	0.70	15.6	0.65	60	14.3	0.87	15.1	0.76	15.6	0.70	15.6	0.65	60	14.2	0.59	15.0	0.54	15.5	0.54	15.5	0.54						
55	16.3	0.72	17.0	0.64	17.4	0.64			55	16.2	0.60	16.9	0.55	17.3	0.53			55	16.0	0.37	16.8	0.33	17.2	0.33								
50	18.1	0.57	18.7	0.51	18.9	0.53			50	18.0	0.43	18.6	0.41	18.8	0.40			50	17.8	0.20	18.5	0.18	18.7	0.18								
45	19.7	0.42	20.4	0.40	20.3	0.40			45	19.6	0.30	20.2	0.27	20.3	0.27			Critical boom angle	49°		49°		49°		59°							
40	21.1	0.30	21.6	0.29					40	21.0	0.19	21.5	0.18					Standard hook	for 1.8 ton													
35	22.3	0.22	22.7	0.20					Critical boom angle	39°		39°		44°		59°		Hook mass	25kg													
Critical boom angle	34°		34°		44°		59°		Standard hook	for 1.8 ton								Hook mass	25kg													
Standard hook	for 1.8 ton								Hook mass	25kg								Parts of line	1													
Hook mass	25kg								Parts of line	1																						
Parts of line	1																															

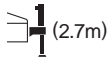

## 24.0m Boom + 3.6m Jib

 (2.7m)								
Outriggers intermediately extended (over side)								
Boom angle (°)	Offset 5°		Offset 25°		Offset 45°		Offset 60°	
	Working radius (m)	Load (ton)	Working radius (m)	Load (ton)	Working radius (m)	Load (ton)	Working radius (m)	Load (ton)
82	4.4	1.60	5.8	1.50	6.5	1.00	6.8	0.65
80	5.2	1.60	6.4	1.50	7.2	1.00	7.4	0.65
75	7.8	1.20	8.7	1.05	9.5	0.93	9.6	0.65
70	10.0	0.72	10.9	0.65	11.5	0.62	11.7	0.56
65	11.9	0.41	12.9	0.35	13.4	0.34	13.6	0.33
Critical boom angle	64°		64°		64°		64°	
Standard hook	for 1.8 ton							
Hook mass	25kg							
Parts of line	1							

## 24.0m Boom + 5.5m Jib

 (4.75m)								 (4.3m)												
Outriggers fully extended (360° full range)								Outriggers intermediately extended (over side)												
Boom angle (°)	Offset 5°		Offset 25°		Offset 45°		Offset 60°		Boom angle (°)	Offset 5°		Offset 25°		Offset 45°		Offset 60°				
	Working radius (m)	Load (ton)	Working radius (m)	Load (ton)	Working radius (m)	Load (ton)	Working radius (m)	Load (ton)		Working radius (m)	Load (ton)	Working radius (m)	Load (ton)	Working radius (m)	Load (ton)	Working radius (m)	Load (ton)			
82	4.8	1.00	6.9	1.00	8.2	0.65	8.6	0.40	82	4.8	1.00	6.9	1.00	8.2	0.65	8.6	0.40			
80	5.6	1.00	7.6	1.00	8.9	0.65	9.2	0.40	80	5.6	1.00	7.6	1.00	8.9	0.65	9.2	0.40			
75	8.4	1.00	10.1	0.85	11.2	0.63	11.5	0.40	75	8.4	1.00	10.1	0.85	11.2	0.63	11.5	0.40			
70	11.1	1.00	12.4	0.72	13.4	0.58	13.6	0.40	70	11.1	1.00	12.4	0.72	13.4	0.58	13.6	0.40			
65	13.4	0.81	14.7	0.61	15.6	0.52	15.6	0.40	65	13.4	0.81	14.7	0.61	15.6	0.52	15.6	0.40			
60	15.6	0.69	16.8	0.55	17.5	0.48	17.4	0.40	60	15.5	0.69	16.8	0.55	17.5	0.48	17.4	0.40			
55	17.7	0.58	18.8	0.49	19.3	0.45			55	17.6	0.54	18.7	0.49	19.2	0.45					
50	19.6	0.49	20.5	0.44	20.8	0.41			50	19.5	0.38	20.4	0.36	20.7	0.35					
45	21.2	0.38	22.0	0.36	22.3	0.36			45	21.0	0.27	21.8	0.25	22.1	0.25					
40	22.9	0.26	23.4	0.26					Critical boom angle	44°		44°		44°		59°				
Critical boom angle	39°		39°		44°		59°		Standard hook	for 1.8 ton										
Standard hook	for 1.8 ton								Hook mass	25kg										
Hook mass	25kg								Parts of line	1										
Parts of line	1																			

## 24.0m Boom + 5.5m Jib

 (3.7m)								 (2.7m)											
Outriggers intermediately extended (over side)								Outriggers intermediately extended (over side)											
Boom angle (°)	Offset 5°		Offset 25°		Offset 45°		Offset 60°		Boom angle (°)	Offset 5°		Offset 25°		Offset 45°		Offset 60°			
	Working radius (m)	Load (ton)	Working radius (m)	Load (ton)	Working radius (m)	Load (ton)	Working radius (m)	Load (ton)		Working radius (m)	Load (ton)	Working radius (m)	Load (ton)	Working radius (m)	Load (ton)	Working radius (m)	Load (ton)		
82	4.8	1.00	6.9	1.00	8.2	0.65	8.6	0.40	82	4.8	1.00	6.9	1.00	8.2	0.65	8.6	0.40		
80	5.6	1.00	7.6	1.00	8.9	0.65	9.2	0.40	80	5.6	1.00	7.6	1.00	8.9	0.65	9.2	0.40		
75	8.4	1.00	10.1	0.85	11.2	0.63	11.5	0.40	75	8.4	1.00	10.1	0.85	11.2	0.63	11.5	0.40		
70	11.1	1.00	12.4	0.72	13.4	0.58	13.6	0.40	70	10.8	0.66	12.3	0.55	13.3	0.48	13.6	0.40		
65	13.4	0.75	14.7	0.61	15.6	0.52	15.6	0.40	65	12.9	0.36	14.4	0.30	15.3	0.26				
60	15.4	0.52	16.7	0.45	17.5	0.42	17.4	0.40	Critical boom angle	64°		64°		64°		69°			
55	17.4	0.31	18.6	0.28	19.1	0.28			Standard hook	for 1.8 ton									
52	18.5	0.22	19.5	0.21	20.0	0.20			Hook mass	25kg									
Critical boom angle	51°		51°		51°		59°		Parts of line	1									
Standard hook	for 1.8 ton																		
Hook mass	25kg																		
Parts of line	1																		

## ■ Notes for the lifting capacity chart

### ■ When the outriggers are used

1. The lifting capacity chart indicates the maximum load which can be lifted by this crane provided it is level and standing on firm level ground. The values in the chart include the mass of the main hook and slings for boom operation, and auxiliary hook and slings for jib operation.

[13 ton hook (mass: 90 kg), 1.8 ton hook (mass: 25 kg)]

Within the chart the figures in the area bordered with a thick line are based on structural limitations while other figures are determined by stability limitations.

2. The working radii are the actual values allowing for boom and jib deflection. Therefore you must always operate the crane on the basis of the working radius.
3. The jib working radius is based on the jib mounted on the end of the 24.0 m boom. When operating at other boom lengths, use the boom angle alone as the criterion.
4. Do not operate the jib when the outriggers are completely retracted.
5. The lifting capacities for the over sides vary with the outriggers extension width. Therefore for each outriggers extension condition you should work according the lifting capacity chart.

Use the lifting capacity chart of outriggers full extended for both front and rear areas lifting capacities.

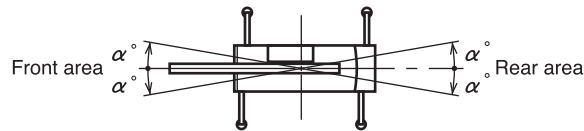

Outrigger extension status	Intermediate extension (4.3m)	Intermediate extension (3.7m)	Intermediate extension (2.7m)	Full retraction
Area $\alpha^\circ$	25	25	15	3

6. The lifting capacity of the rooster sheave is the lifting capacity of the boom minus the mass of all attached hook, slings etc. to the boom, with an upper limit of 1,800 kg.

[The hook for use with the rooster sheave is the 1.8 ton hook (mass: 25 kg) with one part of line.]

7. If the boom length, boom angle, working radius and/or jib angle exceeds the rated value, use the lifting capacity for the rated value or for the next one, whichever gives the smaller lifting capacity.
8. If you are working with the boom while the jib is rigged, subtract 600 kg plus the mass of all attached hook, slings, etc. to the boom from the each lifting capacity of the boom, with an upper limit of 5 ton.  
Do not use the rooster sheave in this situation. And do not operate the boom while the jib is rigged, when the outriggers are completely retracted.
9. In whatever working conditions the corresponding boom critical angle is shown in the chart. The crane can tip over if the boom is lowered below the critical angle even if unloaded.  
Therefore, never lower the boom below these angles.
10. The standard parts of line for each boom length are as indicated in the chart. If you work with a non-standard number of parts of line, do not exceed 15.7 kN (1.6 tf) per wire rope respectively.
11. High-speed lowering operation should only be performed to allow descent of the hook alone.  
Avoid sudden lever operation.
12. Crane operation is permissible up to a wind speed of 10 m/s. Even in relatively light wind conditions, extra care should be taken when handling loads presenting large wind catching areas.
13. Kato bears no liability whatsoever for crane tipping or damage caused by crane operations with a load in excess of the lifting capacity or incorrect procedure.

■ When the outriggers are not used

1. The lifting capacity chart indicates the maximum load the crane can lift when its body is level on firm level ground with all tires inflated to the rated pressure and the suspension cylinder completely retracted. The values in the chart include the mass of the main hook and slings.

Within the chart the figures in the area bordered with a thick line are based on structural limitations while other figures are determined by stability limitations.

[Rated tire pressure: 875 kPa (8.75 kgf/cm<sup>2</sup>)]

2. The working radii are the actual values allowing for boom deflection. Therefore you must always operate the crane on the basis of the working radius.

3. The lifting capacity differs between the front area capacity and the full range capacity. When slewing from the front to the side, take care that the crane could not be over loaded.

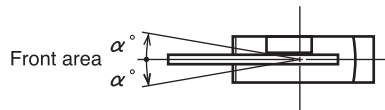

Crane operation	Stationary crane-on-rubber operation	Pick and carry operation
Area $\alpha^\circ$	1	1

4. Do not work with the jib or with a boom length of more than 12.78 m.

5. For stationary crane-on-rubber operation, the parking brake and service brake lock device must be engaged.

6. For pick and carry operation, the shift lever set to speed 1.

7. For pick and carry operation, lower the load to just above the ground and keep your speed strictly below 2 km/h to avoid swinging the load.

Take particular care to avoid sharp turns, sudden starts and stops.

8. Never operate the crane during pick and carry operation. The slewing brake must be applied.

9. The lifting capacity of the rooster sheave is the lifting capacity of the boom minus the mass of all attached hook, slings etc. to the boom, with an upper limit of 1,800 kg.

[The hook for use with the rooster sheave is the 1.8 ton hook (mass: 25 kg) with one part of line.]

10. If the boom length, boom angle, working radius and/or jib angle exceeds the rated value, use the lifting capacity for the rated value or for the next one, whichever gives the smaller lifting capacity.

11. In whatever working conditions the corresponding boom critical angle is shown in the chart. The crane can tip over if the boom is lowered below the critical angle even if unloaded.

Therefore, never lower the boom below these angles.

12. The standard parts of line for each boom length are as indicated in the chart. If you work with a non-standard number of parts of line, do not exceed 15.7 kN (1.6 tf) per wire rope respectively.

13. High-speed lowering operation should only be performed to allow descent of the hook alone.

Avoid sudden lever operation.

14. Crane operation is permissible up to a wind speed of 10 m/s. Even in relatively light wind conditions, extra care should be taken when handling loads presenting large wind catching areas.

15. Kato bears no liability whatsoever for crane tipping or damage caused by crane operations with a load in excess of the lifting capacity or incorrect procedure.

# WORKING RANGE

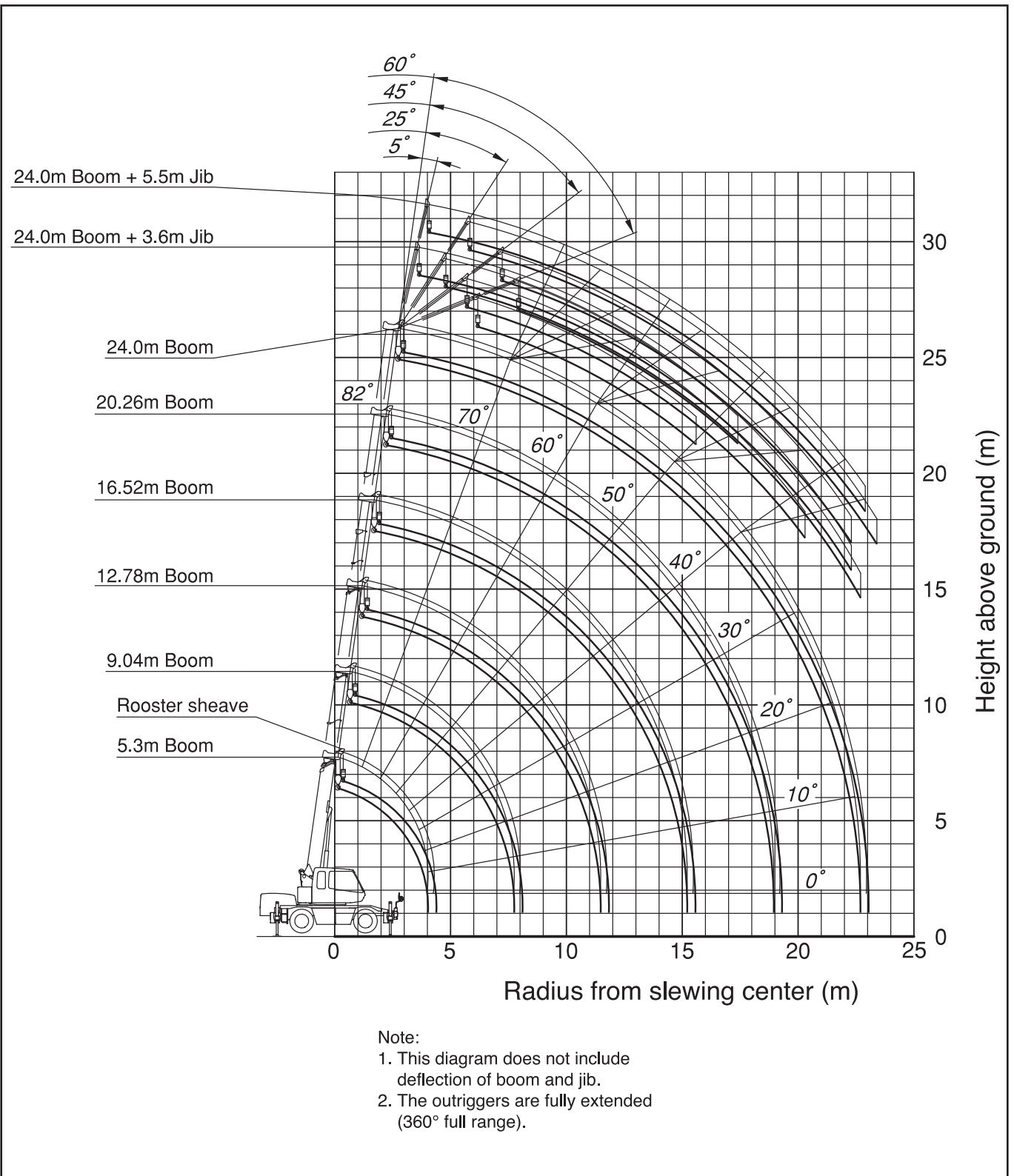



## Minimum path width

### ● Right turn in two-wheel steering mode

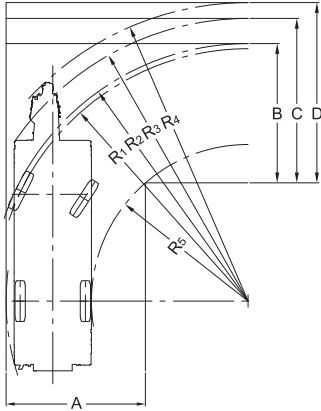

- $R_1=6.50\text{m}$   
(Minimum turning radius)
- $R_2=6.64\text{m}$   
(Turning radius of extremely outer tire)
- $R_3=7.28\text{m}$   
(Chassis turning radius)
- $R_4=7.69\text{m}$   
(Boom end turning radius)
- $R_5=4.03\text{m}$   
(Turning radius extremely chassis inner)
- $A=3.59\text{m}$  (Width of entrance)
- $B=3.59\text{m}$  (Width of wheel exit)
- $C=4.24\text{m}$  (Width of chassis exit)
- $D=4.65\text{m}$  (Width of exit at end of boom)

### ● Right turn in 4-wheel steering mode

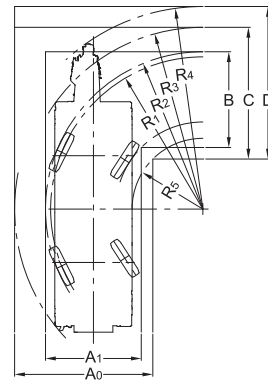

- $R_1=3.92\text{m}$   
(Minimum turning radius)
- $R_2=4.06\text{m}$   
(Turning radius of extremely outer tire)
- $R_3=4.68\text{m}$   
(Chassis turning radius)
- $R_4=5.22\text{m}$   
(Boom end turning radius)
- $R_5=1.82\text{m}$   
(Turning radius extremely chassis inner)
- $A_0=3.56\text{m}$  (Width of chassis entrance)
- $A_1=2.47\text{m}$  (Width of wheel entrance)
- $B=2.47\text{m}$  (Width of wheel exit)
- $C=3.40\text{m}$  (Width of chassis exit)
- $D=3.93\text{m}$  (Width of exit at end of boom)

Note: The above values are based on calculations.

## Overall view

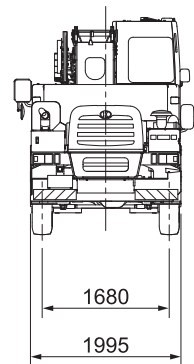
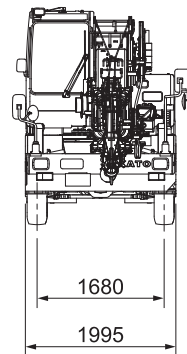
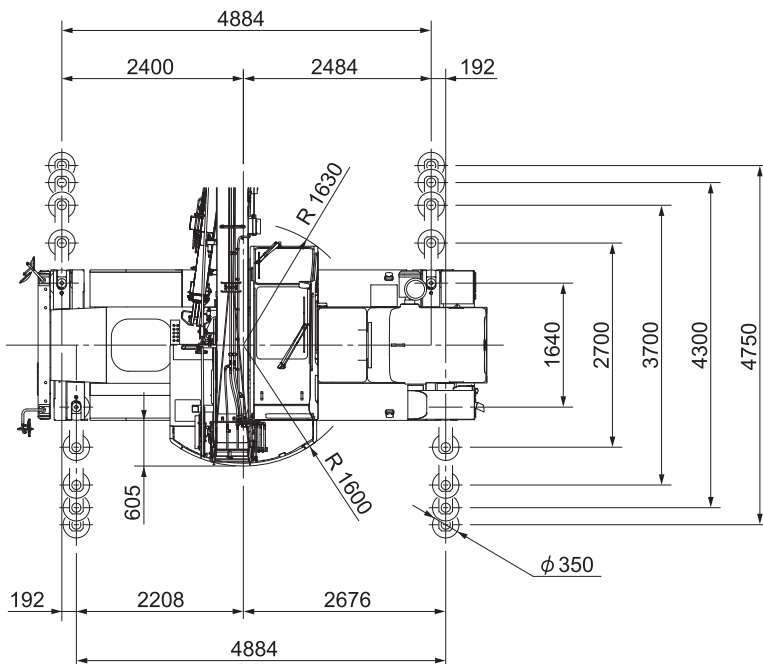

Reduced scale: 1/100 Unit (mm)

